

Adsorber VL-R series

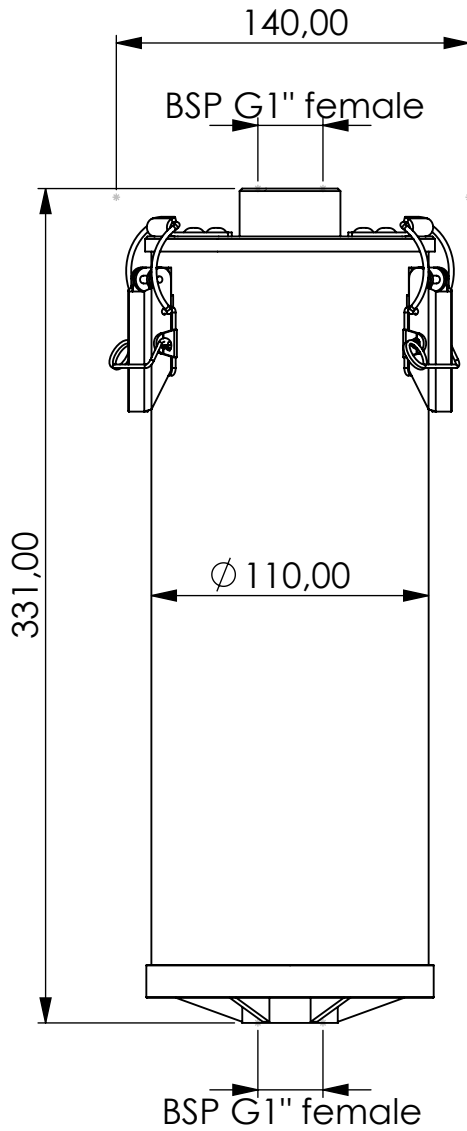

Product Code	VL	-	R	-	3L	-	F	-	V2	-	C	-	G1f	-	G1f
	Adsorber type		Refillable cartridge		Size		FKM seals		Fleece filter 2 micron		Adsorbent Carbon		Connection for System BSP G1" female		Connection for System BSP G1" female

Housing materials:	PA6, PC, AL
Carbon (kg):	1.1
Total weight (kg):	2.171
NAME:	Adsorber VL-R 3L C G1"f VL-R_3L_F_V2_C_G1f_G1f
Article no.:	12.0001.20
Status approved	Format A4
Ratio 1:3	Sheet / of 1 / 1

	Date	Name
rev.	18.12.2023	Daniel Zinic
GIEBEL FilTec GmbH		
www.giebel-adsorber.com		
info@gf-dry.com		



GIEBEL Adsorber®
...setting standards in aeration drying!