

Adsorber MA-RV series

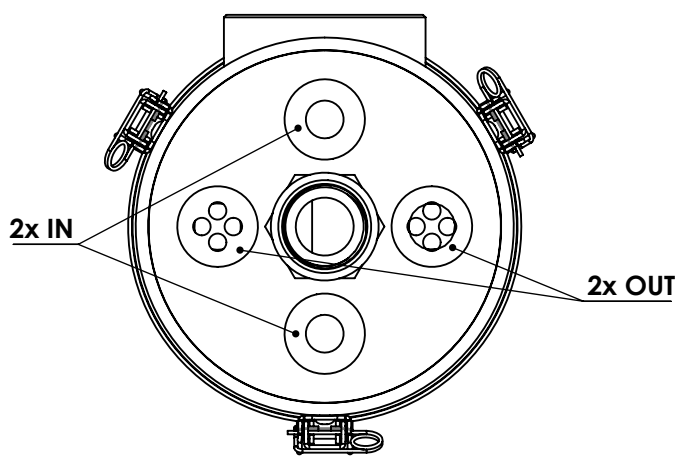
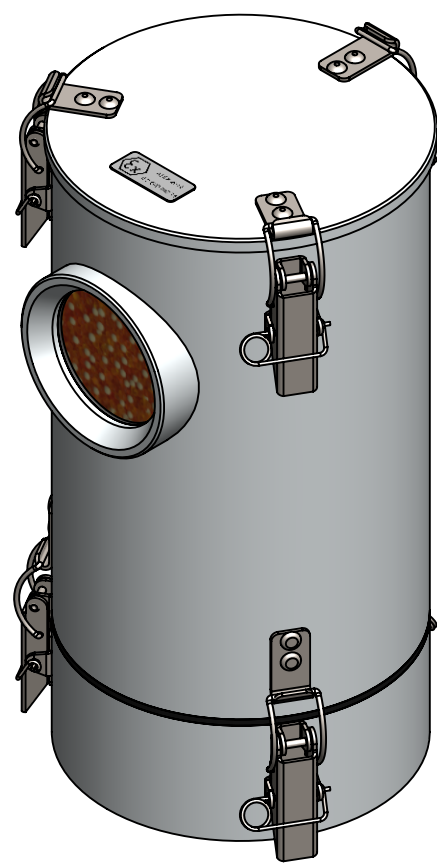
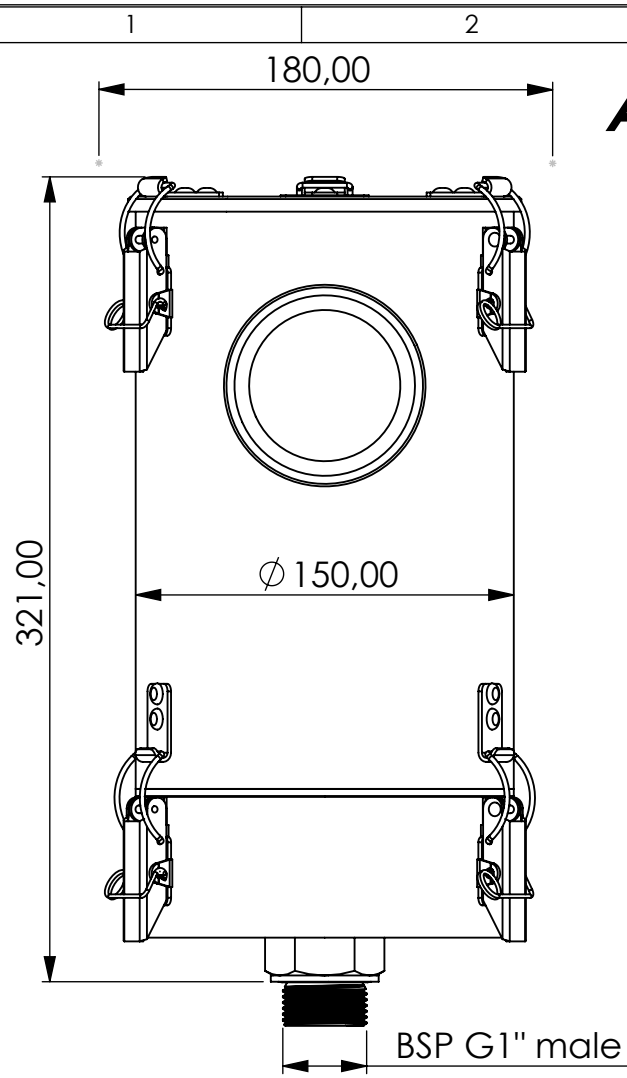

Product Code	MA	-	RV	-	5M	-	F	-	22	-	P3	-	XC	-	G1m
	Adsorber type		Refillable cartridge + valves		Size		FKM seals		Check valves 2 IN 2 OUT		Paper filter 3 micron		Adsorbent GIEBEL Xdry® & carbon		Connection for System BSP G1" male

Housing materials:	Aluminium	
GIEBEL Xdry® (kg):	2.1	Color-change capacity (ml): 735
Total weight (kg):	5.16	

NAME:
Adsorber MA-RV 5M G1"m
MA-RV_5M_F_22_P3_XC_G1m



GIEBEL FilTec GmbH
www.giebel-adsorber.com
info@gf-dry.com

Article no.:	08.0003.09	Status freigabe	Format A4
		Maßstab	Blatt / von
		1:3	1 / 1

Weitergabe sowie Vervielfältigung dieses Dokuments, Verwertung und Mitteilung seines Inhalts sind verboten, soweit nicht ausdrücklich gestattet. Zuwiderhandlungen verpflichten zu Schadensersatz. Alle Rechte für den Fall der Patent-, Gebrauchsmuster- oder Geschmacksmusterreife vorbehalten.